

Assembly Instructions for 10U/12U 6'6"x18' Goals

Goal contains 18 parts

- 4 short straight crossbar connectors (with pushbuttons on both sides)
- 6 straight bars for top and bottom crossbars (3 for top, 3 for bottom)
- 2 bottom basebars with attached corner
- 2 bottom corner connectors
- 2 side bars
- 2 top corner connectors

Plus

- 4 stakes
- 2 corner flags

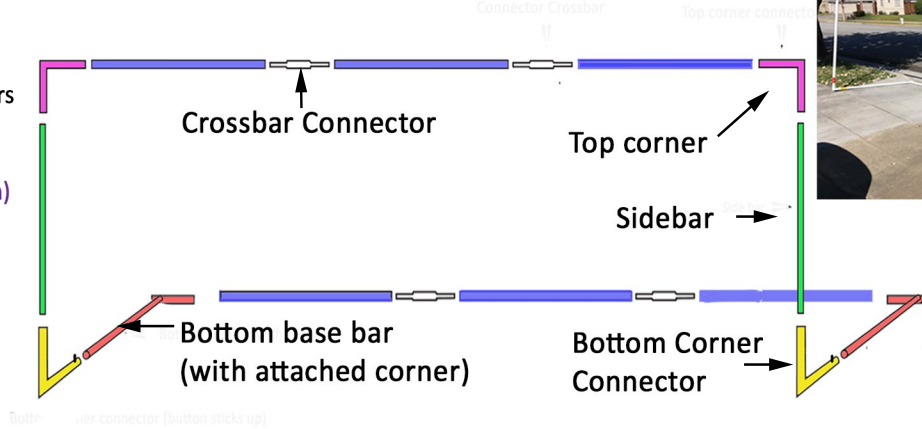

Layout the 5 straight top crossbar parts and the 5 straight bottom crossbar parts first
Then layout the remaining side and corner parts.

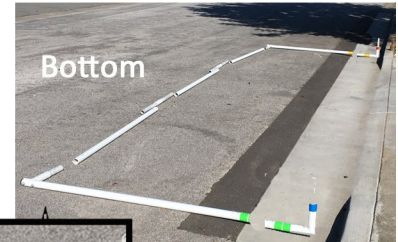

Bottom base bar has bolted preattached corner

Connect the top 5 crossbar parts using the push buttons.
Then repeat the same for the bottom crossbar.

DO NOT hammer the pieces in place. Mallets are for stakes.

Push-button assembly

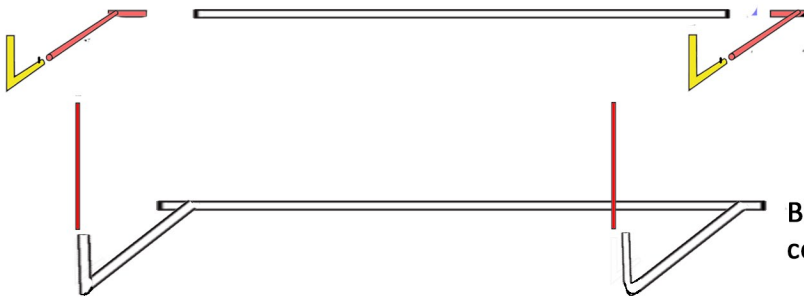
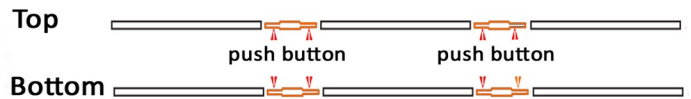
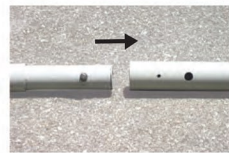

BOTTOM: Connect the 2 bottom side base bars to the bottom crossbar. Then connect the 2 corner connectors which will point up. (Note: The bottom corner connectors have a push buttons that face in. This is different from top corner connectors)

BOTTOM: Insert the sidebars and connect the side bars to the bottom base.

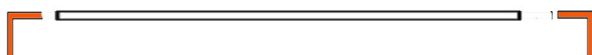

TOP: Attach the top corners to the top cross bar

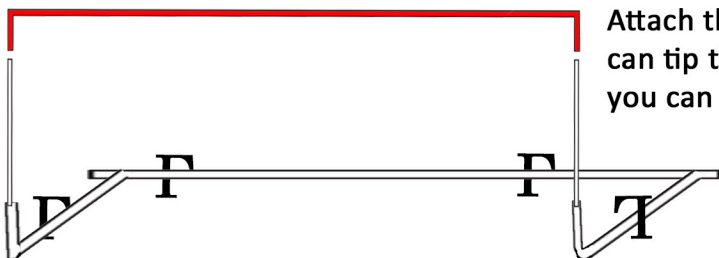

Attach the top cross bar to the rest of the base. (You can tip the base over to lay it flat on the ground so you can connect the top bar.)

Attach the net with velcro and then stake the bottom of the goal with the 4 stakes - 2 in back and 1 on each side. Use the goal bag on the back bar to help anchor the back of the net.

